

INSTALLATION & USER INSTRUCTIONS

Thank you for purchasing this Whale® product.

For over 60 years, Whale® has led the way in the design and manufacture of freshwater and waste systems including: pumps, plumbing faucets, showers for low voltage applications. The company and its products have built a reputation for quality, reliability and innovation backed up by excellent customer service.

Typical Installation

The Watermaster® IC is designed for use in recreational vehicles to simplify the supply of freshwater to caravans and motorhomes, where a Whale® High Flow Watermaster® pump is used to supply the taps and showers. Please note that caravan water systems and domestic water systems differ. Please exercise caution when using the hot water supply. It is possible to get unmixed hot water when the tap or shower is initially opened.

The Watermaster® socket (already installed or available separately) **must be** mounted so that the rear of the socket is accessible from within the vehicle. Ensure at least 30mm clearance below the socket to allow for wiring.

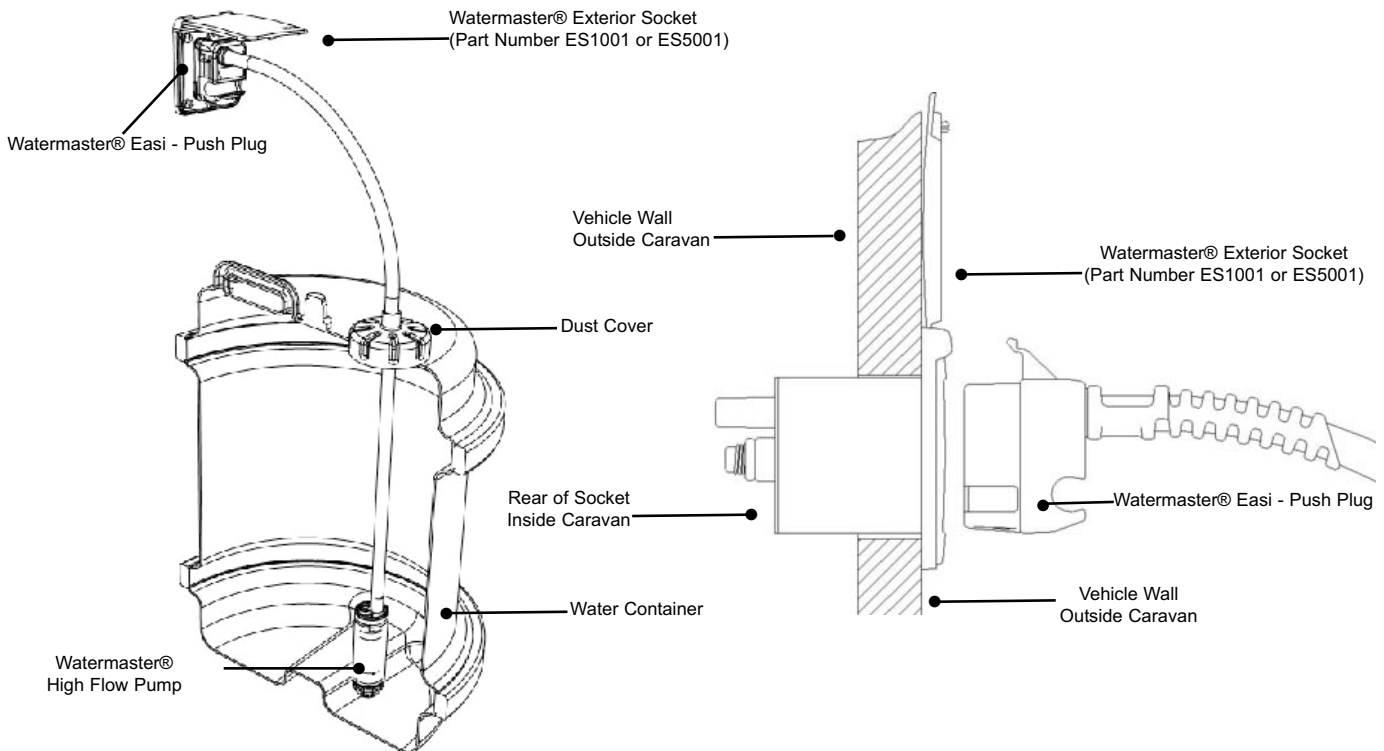

Fig 1: Pump Location

Fig 2: Socket Location

Following a simple calibration process the Watermaster® IC:-

- removes the need for adjustment of the pressure switch
- removes the requirement to have a surge damper in the system
- switches off the pump when it runs dry.

For information on our full product range visit: www.whalepumps.com

This product is designed for use with freshwater. If it is intended for use with any other liquid, it is the user's responsibility to ensure that the materials are fully compatible with the liquids to be used and that a system of safe working practice is applied to installation, use and maintenance.

SPECIFICATION

Product Codes	EP1632
Voltage	Voltage range 9.5V d.c. to 14.5V d.c. (normal operation) Voltage range 8.5V d.c. to 9.5V d.c. (limited operation)
Nominal Current	Operating 3.7 Amps Standby 0.007 Amps
Recommended Fuse Size	5 Amp automotive
Weight	0.65kg
Materials	Pump Body: ABS, Seals: Nitrile®, Strainer: Polypropylene Impeller: PBT, Cable: PVC, Grease Seal: Nitrile® Wire: PVC insulated copper, Hose: PVC, Plug: PBT Watermaster IC: Polycarbonate
Accessories	WF1230 – inline water filter (available separately)
Service Kits	Watermaster® IC is not a serviceable part EP1612 - Replacement High Flow plug and pump kit
Performance Data @ 13.6V Discharge Head - 0 m (0ft) 1 m (3ft) 3 m (9ft)	Flow Rate Per Minute / Current Draw - 15.8 ltrs / 3.8 amps 14.8 ltrs / 3.7 amps 12.8 ltrs / 3.5 amps
Compatible Pumps	For use with Whale® High Flow Watermaster® (EP1612) only
Operating Temperature Range	3°C to 40°C
Storage Temperature Range	-30°C to 60°C

Whale's policy is one of continuous improvement and we reserve the right to change specifications without prior notice.

1. PRINCIPLES OF OPERATION

The Watermaster® IC is a means of control for the Whale Watermaster® High Flow pump, which allows it to operate without the need for pressure switch adjustment. It offers three key features:- eliminates rapid water pulsation, ensures that the pump turns off at low battery voltages and also in a run-dry situation when the water supply runs out.

This Intelligent Control® is achieved as the pressure switch turns the pump on when the pressure drops to a low level and the microprocessor turning off the pump at programmed current levels. These current levels are set during the simple calibration process. This calibration process may have to be repeated if the pump is replaced.

To the Fitter:

Check that the product is suitable for the intended application, follow these installation instructions and ensure all relevant personnel read the points listed below. Also ensure that these operating instructions are passed on to the end user.

To the User:

Please read the following carefully before installation

- Removes the need for adjustment of the pressure switch, and removes the requirement to have a surge damper or inline pressure switch in the system.
- Watermaster® IC is pre-programmed and must initially be calibrated before use - see Section 6.
- When the system has shut down due to running out of water, reset by turning the pump isolation switch off and back on after refilling the tank.
- If the battery voltage is very low (8.5V and 9.5V), the Watermaster® IC is designed to shut down after approximately 30 seconds operation to prevent the battery being drained further. Restart the system by turning the pump isolation switch off and back on. This can be repeated to provide a limited operating mode but the battery should be recharged as soon as possible.
- Please remember that caravan water systems differ from domestic water systems and for this reason it is important to exercise extreme caution when using the hot water supply as it is easier to get unmixed hot water when the tap or shower is initially opened.

2. APPLICATION

Please note that Watermaster® IC is designed to work with the Whale® Pressure Switched Socket (Part Number ES1001 or ES5001), and with the Whale® High Flow Watermaster® pump kit ONLY. It is not compatible with other sockets or pump systems

For users with other Whale® or non-Whale® products, their systems may be upgraded to IC by purchase of the Whale product codes - socket ES1001 or ES5001 and Pump & Watermaster® IC Kit (EP1632).

3. WARNINGS



- This product is not designed for any other purpose than supplying water to a caravan or other recreational vehicle system.
- Please note that caravan water systems and domestic water systems differ. Please exercise caution when using the hot water supply. It is possible to get unmixed hot water when the tap or shower is initially opened.
- Always disconnect power sources before installing or making connections.
- Wiring must comply with applicable electrical standards and include a 5 Amp automotive fuse or circuit breaker. Improper wiring can cause a fire resulting in injury or death. Suggested wiring information is given as a guide only.
- Please note that incorrect installation may invalidate the warranty.
- The Watermaster® IC is designed to work in conjunction with a 5 Amp automotive fuse (see fuse box for fuse marked 'pump').
- The Watermaster® socket (already installed or available separately) **must be** mounted so that the rear of the socket is accessible from within the vehicle. Ensure at least 30mm clearance below the socket to allow for wiring.
- Please note that incorrect wiring will result in a blown fuse.
- Please note that Watermaster® IC is designed to work in conjunction with the Whale Watermaster® 12V d.c High Flow Pump with Easi - Press™ Plug (EP1612) and the Whale Watermaster® Pressure Switched Socket (ES1001 or ES5001) ONLY and will not operate with any other Whale® products.
- Please note that the Watermaster® IC Pump Controller MUST be calibrated to the High Flow Pump that will be used with the van. If the pump is replaced, the Watermaster® IC Pump Controller MUST be recalibrated to the new pump.

With all applications it is important that a system of safe working practice is applied to installation, use and maintenance.

- Please note that the Watermaster® IC controller unit is enclosed to protect the electronics. Opening the unit will result in damage and will invalidate warranty.
- **Do not** use the pump in water temperatures above 40°C (100°F).
- It is best to stand the pump vertically in the tank.
- Contact Whale® Support on 028 9127 0531 for additional advice on this product or its installation.

4. PARTS LIST

- Qty 1 Watermaster® IC Control Unit
- Qty 1 Securing screw
- Qty 1 Watermaster® 12V d.c. High Flow Pump with Easi - Press™ Plug

5. OPTIONAL EXTRAS

Part Number (Available Separately)	Description
GP1652	Whale Watermaster® High Flow Pump
EP1612	Whale Watermaster® High Flow Pump with Easi - Press™ Plug
EP1632	Whale Watermaster® IC Kit - includes Watermaster® IC Control Unit and Watermaster® 12V d.c. High Flow Pump with Easi - Press™ Plug

6. INSTALLATION

Please note - The manufacturer cannot be held responsible for claims arising from incorrect installation, unauthorised modification or misuse of this product.

Before installing, please check that the submersible pump can reach the bottom of the water container (see Fig. 1) and that there is access to the back of the socket (see Fig. 2). Ensure that the system is fully drained before starting the installation. To do this open and close all outlets to expell water and air.

CONNECTING THE IC CONTROL UNIT (to the back of socket)

Step One - Switch off the 12V d.c. supply at the main panel (isolator switch).

Step Two - Unplug the 3 electrical spade connections (Negative, Positive and Pump Running Light) at the bottom the water inlet socket. Please ensure that you note the order of wires for reconnection to the Watermaster® IC Control Unit (see Fig. 1 & Fig. 2 below).

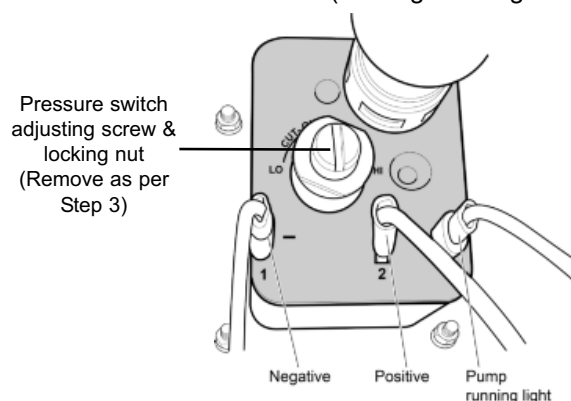

Fig. 3 Wiring connections Watermaster® socket

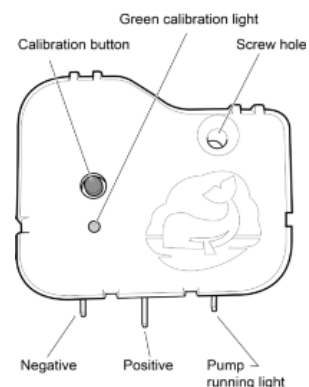

Fig. 4 Watermaster® IC features

Step Three - Unscrew and remove the pressure switch adjusting screw and locking nut (see Fig 1 above).

Step Four - Remove securing screw (see Fig. 5 below)

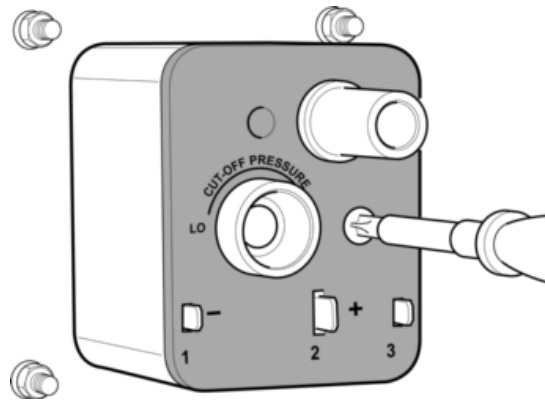

Fig. 5 Removing Securing Screw

Step Five - Take the Watermaster® IC Control unit and place countersunk screw (Included) into screw hole on the Watermaster® IC Control unit (see Fig. 4 below).

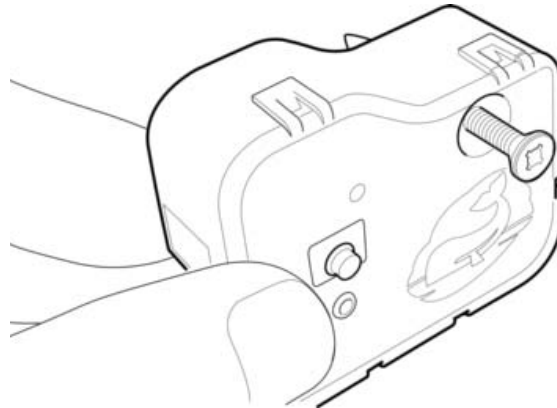

Fig. 6 Place Securing Screw into Watermaster® IC Control Unit

Step Six - Plug Watermaster® IC Control Unit onto socket (see Fig. 5 below) and tighten screw (N.B – **Do not** over tighten)

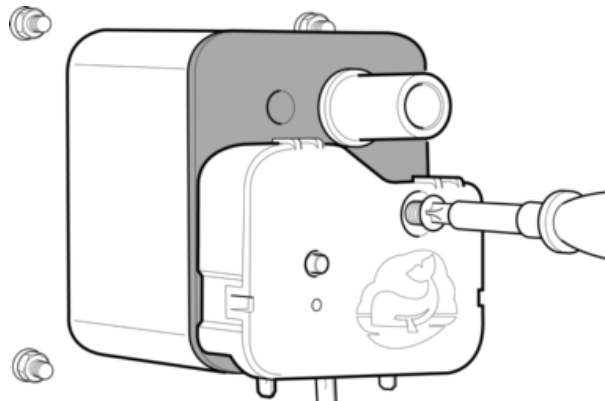

Fig. 7 Insert screw into Watermaster® IC

Step Seven - Reconnect the 3 electrical spade connectors, ensuring correct order of wires (as per Step One).

CONNECTING YOUR PLUG AND PUMP KIT

Prior to using your water system for the first time, **the system will need to be primed** and the **Watermaster IC® unit will need to be calibrated** by following the simple steps below.

To Prime the Water System

Step One - Place the pump into a full water container. Ensure the pump can reach the bottom (as shown in Fig. 1).

Step Two - Insert Easi - Push Plug into socket and close lid to lock into place (see Fig. 8a & 8b below).

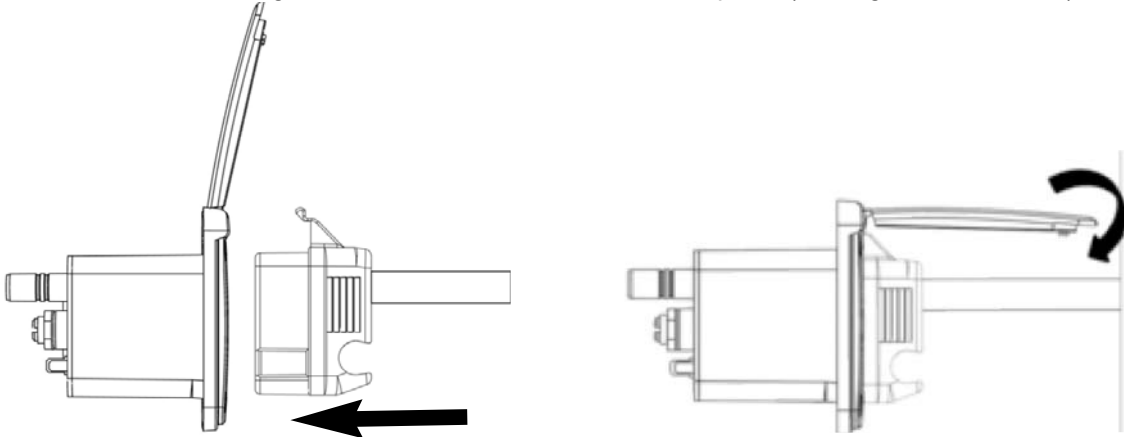

Fig. 8a & 8b Insert Easi - Push Plug and Lock in Place

Step Three - Adjust dust cover over opening in container (please note dust cover should not be secured to water container as air must be allowed to enter container to replace water being pumped out).

Step Four - Switch on 12 volt supply at main panel (Isolator switch) - the pump should start to run.

Step Five - Open the cold shower mixer (or the outlet furthest from the Watermaster® IC Control Unit in the van).

Step Six - After trapped air has been expelled, by following Step Five, water will flow from the open outlet.

Step Seven - When air has been expelled turn off shower, the pump should turn off after approximately 10 seconds.

To Calibrate Your Watermaster® IC Control Unit

To ensure successful installation and optimum performance of the Watermaster® IC Control unit, you **must follow** the 5 simple steps below:-

Step One - Press and hold the calibration button until the green LED starts to flash after 1-3 seconds (see Fig. 9).

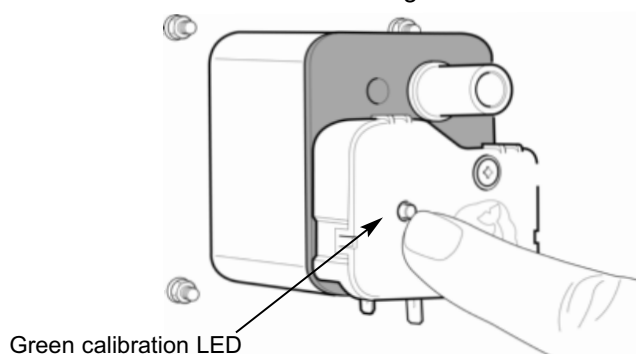

Fig. 9. Calibrating the system

Step Two - Open the cold shower and the pump should start (there may be a short delay).

Step Three - After approximately 30 seconds, turn off the shower.

Step Four - After approximately 10 seconds, (the pump should still be running), press and hold the calibration button again until the LED turns solid green and the pump will stop after approximately 10 seconds.

Step Five - The green LED should turn off and blink briefly every 5 seconds. The system is now calibrated.

The Watermaster® IC is now installed and ready for use. During normal use you will only need to recalibrate if you use a different pump. Simply repeat the steps above to calibrate a new pump.

Please Note: When the tap is first opened a small drop in water pressure is normal until the pump starts running.

Please Note: In normal operation the pump may run for up to 15 seconds after the tap is closed.

Handy Hint: Pump hose can be inserted into groove on plug to keep pump off ground while refilling water container. (Fig. 10). The plug **must always** be removed before moving the caravan/motorhome.

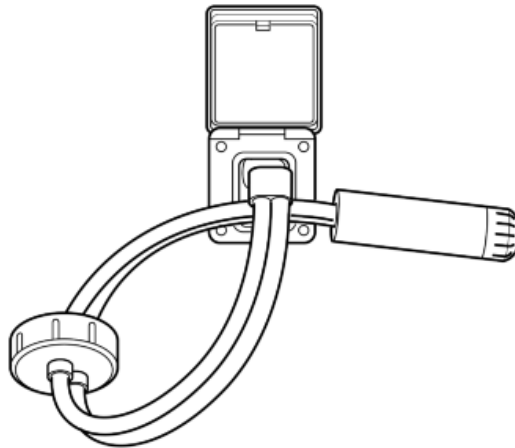

Fig. 10. Handy Hose Holder

Removing the Pump:

Step One - Lift the lid to unlock the plug (See Fig. 11).

Step Two - Pull out plug from socket using hand grip (See Fig. 11).

Step Three - Shut lid.

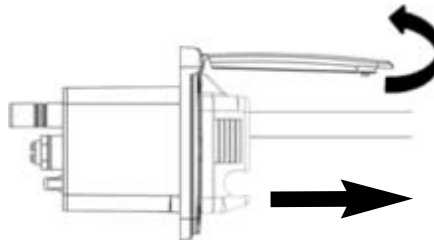

Fig 11. Removing Pump

7. INSTRUCTIONS FOR PUMP STORAGE WHEN NOT IN USE

The plug **must** always be removed from the external water socket before moving the caravan/motorhome and stowed in a clean, dry place.

8. MAINTENANCE

This IC control unit (located on the back of the socket) is designed to be service free and does not contain serviceable parts. Please note that the unit is enclosed to protect the electronics. Opening the unit will result in damage, and will invalidate warranty.

For information on service kits, please visit www.whalepumps.com

9. HELPFUL HINTS

If at any stage the user experiences less than optimum performance from the Whale® Watermaster® IC, recalibrate the system as per steps above in Section 6.

- To obtain efficient running and maximum pump life, ensure the following:
- There is sufficient water in the container.
- Maximum pumping period is not more than 15 minutes.
- All hose connections are firm and water tight.
- The power supply is adequate - low performance could result from a weak battery or reduced voltage due to undersized wiring (we recommend wiring should be a minimum thickness of 2.5mm²).
- When replenishing the water supply, it is possible to create an air lock in the pump. As a result, the pump will run noisily and give no discharge. To remedy, unplug from the socket while keeping the pump submerged to dislodge the air pocket in the pump. Also shaking the dual hose gently may dislodge the air pocket in the pump, or switch off pump at main panel, open a tap outlet and switch pump on again at the main panel.

10. TROUBLE SHOOTING

PROBLEM	POSSIBLE SOLUTIONS
Pump will not run	Check at least one tap is open
	Check the battery condition
	Check the mains isolator switch is on
	Check the pump isolator switch is on
	Check the contacts in the plug and socket are clean and making contact
	Check wiring connections
	Check fuse (see fuse box)
	Turn the pump isolation switch off and on again
The pump cycles on/off with all taps and shower closed	Check for air or water leaks in taps and piping
	Check that the non return valve in socket is free from grit by pushing a suitable blunt object, for example a ballpoint pen into the socket nipple against the non-return valve holding the valve open to dislodge trapped grit
	Check within 1 year warranty. Contact retailer and replace pump
Runs continuously and does not stop after 30 seconds	Check all connections in pipework

Diagnostic Codes

To aid with troubleshooting the LED on the back of the Watermaster® IC has a number of different flash codes as described in the table below

LED	State	Description
Green	Constant On	Tap open, pump running
Green	Fast Flash (< 1 sec)	In Calibration Mode
Green	200ms blink every 5 sec	Calibrated and ready for use
Green	200ms blink every 10 sec	Un-calibrated
Green	200ms blink every 15 sec	Suspended due to dry run need to turn pump switch on and off
Green	200ms blink every 20 sec	Suspended due to low battery voltage, turn pump switch on/off, need to charge battery

11. WINTERISING

Watermaster® IC does not require any additional winterising. For details of how to drain your water system for winterising please visit www.whalepumps.com/rv

12. SERVICE SUPPORT DETAILS

For installation or serviceable parts advice please contact Whale® Customer Support:

Tel: +44 (0)28 9127 0531

Email: info@whalepumps.com
www.whalepumps.com

13. EU DECLARATION OF CONFORMITY, STANDARDS & APPROVALS

Declaration no.: EU-753.133-000

We the undersigned:

Name of manufacturer: Munster Simms Engineering Ltd
Address: 2 Enterprise Road, Bangor, BT19 7TA
Country: Northern Ireland

Declare under our sole responsibility that the following apparatus:

Product description: Pump controller
Model name and no.: Watermaster® IC EP1632
Brand name: Whale

Is in conformity with the following relevant EU Legislation:

EMC directive 2004/108/EC
LVD directive 2006/95/EC

Based on the following harmonized standards:

EN55014-1:2000 EMC Emissions
EN55014-2:1997 EMC Immunity

And therefore complies with the essential requirements of those directives.

Additional information:

Technical file number: TF-753.133-000

Location of technical file: Munster Simms Engineering Ltd, 2 Enterprise Road, Belfast, BT19 7TA

Year mark first applied: 2012

Limitations of use: For use with EP1612 12V submersible pump only

Name and position of person binding the manufacturer or authorized representative:

Signature:



Name: Richard Bovill

Function: Engineering Director

Location: Munster Simms Engineering Ltd
2 Enterprise Road, Belfast, BT19 7TA
Date of Issue: 27.03.12

14. PATENTS AND TRADEMARKS

CE marked

Watermaster® IC is protected by the following pending Patent Application. Patent UK patent application no. 1017025.6

Whale®, Whale Watermaster®, Watermaster® and Intelligent Control® are registered trademarks of Munster Simms Engineering Limited, Bangor, Northern Ireland trading as Whale®.

15. WARRANTY

This product is protected by a 1 year warranty, for full details of our warranty statement please see enclosed leaflet.

©Copyright Whale 2016 - All rights reserved. Reproduction in whole or in part without permission is prohibited. WHALE® is a registered trademark of Munster Simms Engineering Limited, Bangor, Northern Ireland trading as Whale. Whale's policy is one of continuous improvement and we reserve the right to change specifications without prior notice. Illustrations are for guidance purposes only.

Please note that by contacting Whale Support you will be indicating your consent to receiving product updates, recall information, help guides and appropriate marketing messages from us via post, email or telephone unless you indicated an objection to receiving such messages.

Munster Simms Engineering Ltd.
2 Enterprise Road, Bangor, N. Ireland BT19 7TA
Tel: +44 (0)28 9127 0531
Email: info@whalepumps.com
Web: www.whalepumps.com

